

Data Sheet

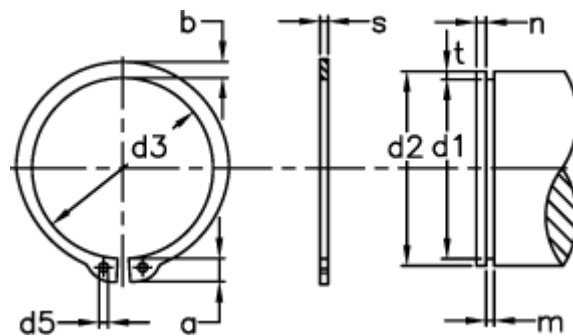

Article number: 0109057
 Description: Retaining ring AS 40x2.5
 Spring steel
 Note: Fitted with ZGA pliers

Measures



a max	= 7.0	Description	= AS 40	s	= 2.50
AN mm ²	= 152.0	FN kN	= 25.30	t	= 1.25
B	= 2.04	FRg kN	= 19.3	tol	= -0.25
b	= 4.4	FR kN	= 104.0	tol	= -0.07
d1	= 37.5	g	= 2.0	tol	= +0,39 -0,90
d2	= 40	m min	= 2.65	Tong	= ZGA-3
d3	= 36.5	n abl x 1000	= 14	Weight kg/1000	= 8.20
d5 min	= 2.5	Nominal drive	= 3.8		